

The Microx Online

Oxygen Analyser With Electrochemical Sensor

User Instruction Manual

Issue Number: 1.14

Issue Date: 17-07-2018



1	Introduction	1
1.1	Microx Online Analyser	1
1.2	Operation	2
1.2.1	%Vol Sensor.....	3
2	Specification	4
3	Physical data	5
3.1	Mounting and Dimensions	5
3.1.1	Field Connections	6
3.1.4	Mounting Locations and Installation	9
3.4	RS232 connections	11
3.5	Analogue Output	11
4	Software Features	12
4.1	Password	12
4.1.1	Menu 1 – Calibrate sensor.....	14
4.1.2	Menu 2 – Analogue output FSD.....	15
4.1.3	Menu 3 – Set 4 mA output.....	15
4.1.4	Menu 4 – Set 20 mA output.....	16
4.1.5	Menu 5 – Analogue Output Simulation	16
4.1.6	Menu 6 – Sensor selection	17
4.1.7	17
4.1.8	17
4.1.9	17
4.1.7	Menu 7.....	17
4.1.8	Menu 8 - Diagnostics.....	17
4.1.9	Menu 9 - Restore	18
4.1.10	Menu 10 – Zero offset	18
4.1.11	Menu 11 – PPM sensor Gain	19
4.1.12	Menu 12 – % vol sensor gain	19
4.1.13	Menu 13 – Sensor damping	20
4.1.14	Menu 14 – New sensor data.....	20
4.1.15	Menu 15 – Electronics zero	21
4.1.16	Menu 16 – Noise Rejection	22
4.1.17	Menu 17 – Relay.....	23
4.1.18	Menu 18 – Alarm levels.....	24
4.1.19	Menu 19 – Alarm hysteresis.....	24
5	Routine Maintenance & Servicing	25
5.1	Routine Inspection and Maintenance	25
5.2	Sensor Replacement	25
5.3	Password	26

1 INTRODUCTION

1.1 Microx Online Analyser

The Microx Online is a wall or surface mounting instrument is for the measurement of % Oxygen volume levels taken from a process line. Typically the sample source would indicate the Oxygen level in the related process and the Microx Online would be configured to initiate an Alarm condition if the Oxygen content measured is too high. This can be typically be for process purity reasons such as in Nitrogen generation processes. Thus the inverse of the Oxygen measurement can also indicate the level of Nitrogen in the process being measured.

Key design features are:

- Sturdy compact enclosure
- Simple keypad calibration facility (utilising onboard LCD display).
- 4-20mA current source output for gas level indication (10-bit resolution).
- 230VAC or 24VDC power supply
- RS232 output for transmission of live data to a PC.
- Status indicating light tower for audible/visual warning as an option.

The Sample gas is supplied from(and exhausted to*) the sample location to the via pipework provided and installed by the customer.

This sample gas is supplied under small positive pressure which can be regulated down to a suitable level via the Regulator device within the Microx Online Analyser.

The Sample gas then enters (and leaves) the Microx Online via integral 6mm Bulkhead fittings.

*Alternatively, The Exhausted sample gas can be piped to a suitable vent location.

Note! This Instrument is for Safe, Non-Hazardous(Non-Ex) locations of operation only.

1.2 Operation

When power is applied to the Microx Online Analyser, an initialisation procedure is performed as follows:

- All the display segments are displayed
- The software version number is displayed
- The company name is displayed
- The sensor type is displayed
- The display then shows the gas level.

The Microx Online is now operational.

Note: The Microx Online Oxygen Monitor is based around the Microx series of Oxygen Analyser controllers and contains some Menu programming options which are not relevant to this Microx product and its mode of operation.

Such menu's and information are highlighted in this user manual as 'Customer Access Not Permitted' and other various warnings against adjustment of such menu options. Please observe these prohibitions to ensure correct operation of the Microx Online Oxygen Analyser

The Microx Online Oxygen Analyser is supplied factory configured and calibrated for correct operation, and apart from sensor replacement and periodic calibration, should require no further user intervention.

1.2.1 %Vol Sensor

A % Volume Electrochemical sensor is an integral part of the Microx Online. The % Volume measurement range of the Microx Online is factory set at 0 to 25%, with calibration at 20.9% O₂.

This model uses Electrochemical technology Sensor which should give accurate trouble free service during its lifetime. This is a consumptive type Sensor and as such disposable* and requires regular periodic calibration and replacement after 1 to 2 years operation(application dependent)

It needs to be ensured that if contaminants are present in the process from where the sample is being taken, these are prevented from entering the pipework and sensor.

Contaminants may include particulates or certain heavy vapours. Inline Filtration of the sample may be required.

*Sensor is not be disposed of into the general waste stream but disposal should be according to local waste recycling requirements, and due to hazardous substances being released on destruction of the Sensor, only approved/certified recyclers should be used for disposal.

2 SPECIFICATION

Supply	
Input Voltage Options:	2310VAC/24 VDC.
Supply current:	140 mA at 24VDC nominal all relays energised, 20 mA drawn on current loop.
Outputs	
Analogue Output:	4-20mA analogue output (10-bit resolution)
Sensor Input	
No of Channels:	1
Sensor	%Vol oxygen 0-25% Electrochemical OC-32
Relays	
3	Single pole change over. Rating 6 Amps 250 v AC
Fuses	
Fuse	500mA anti-surge on board fuse for circuit protection.
Additional Features	
Display:	4 Digit, 7 Segment Display.
Keypad:	4-Button Keypad
Software:	Software configuration, calibration and data logging provided by PC communications.
RS232 Output	
Weight	
	1.3Kg
Dimensions	
	219(265 inc. fittings)x280x156 (LxHxD)
Operating Temp.	
	-30°C to +40°C

3 PHYSICAL DATA

3.1 Mounting and Dimensions

Fig.1 shows the overall dimensions of the Gasenz on line.

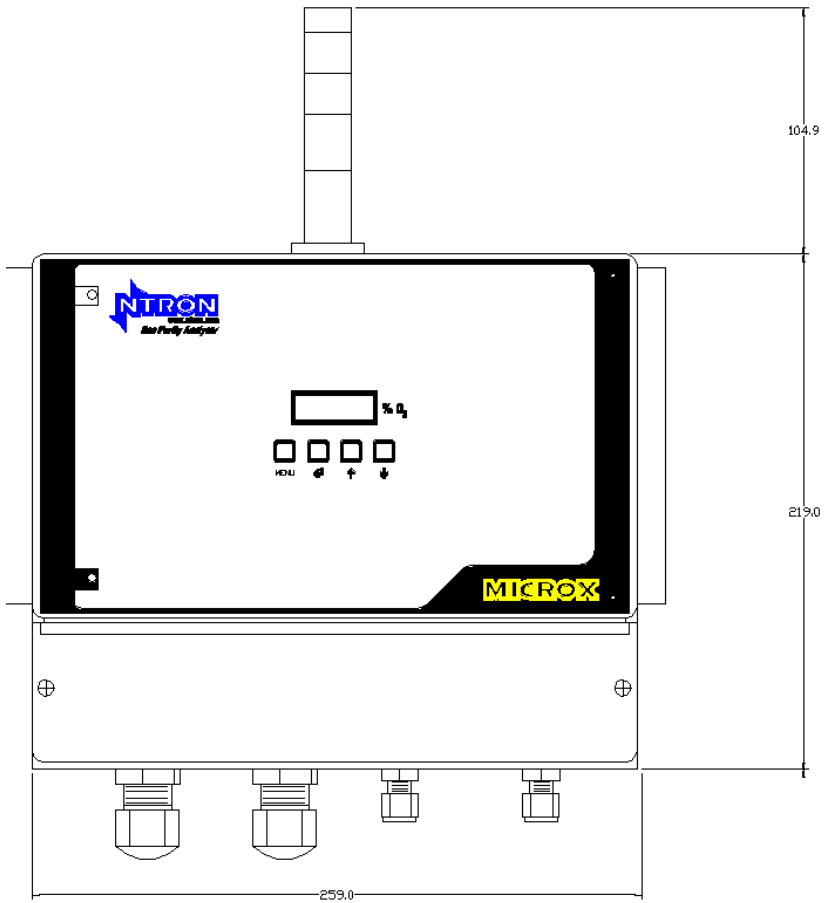

3.1.1 Field Connections

All connections to the module are provided in the form of screw terminals. Access is gained by opening the Microx Online enclosure to reveal the terminal connector strips on the rear of the control module backplate

NOTE: Confirm the Voltage supply option of the instrument before connecting power.(230VAC or 24VDC)

The user field connection points are illustrated below. Cable glands are provided for power and interface cabling.

The User is to make all field connections in suitable cable to local regulation codes and taking into account the power requirements of the instrument as detailed in section 2 (Specification) of this manual.

MICROX CONTROL PCB
CONNECTION DETAILS

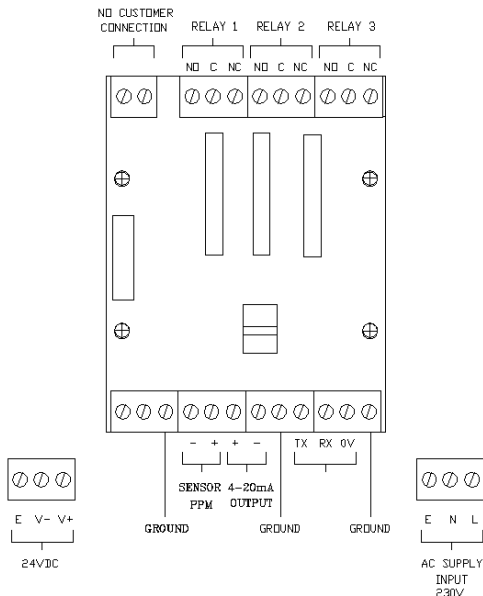

The AC supply connection should be protected by an upstream protective device. 24VDC is available at the 24VDC terminals if an AC supply is connected. If AC mains supply is not available then it is possible to power the unit from 24VDC source via these terminals.

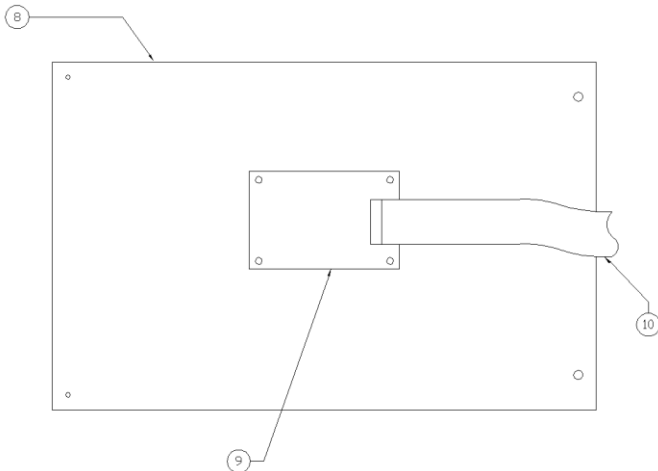
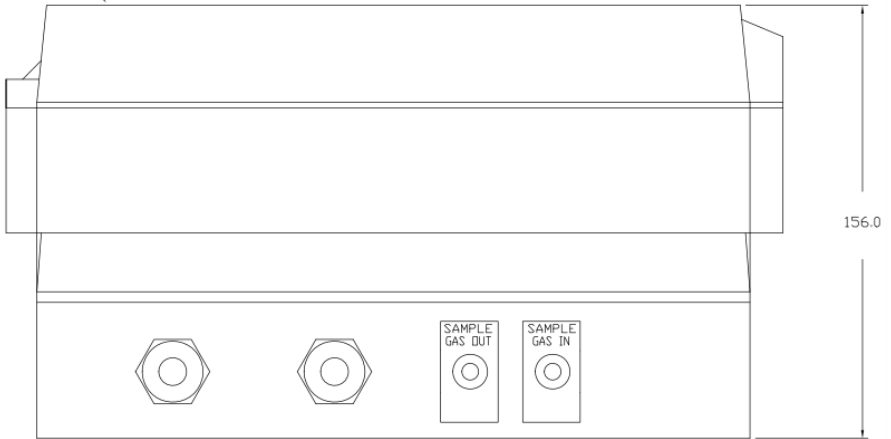

(WITH FRONT PLATE AND COVERS REMOVED)

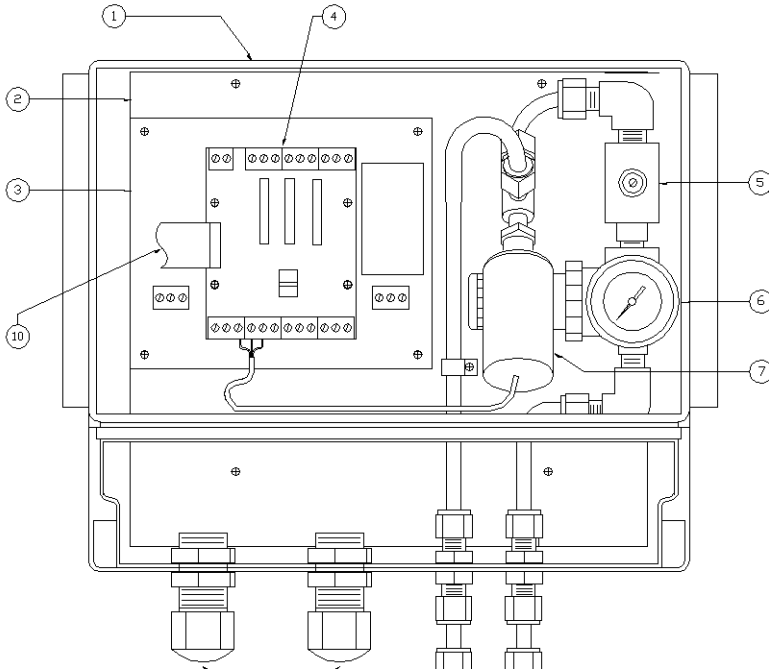

ITEM	DESCRIPTION
1	ABS ENCLOSURE
2	INTERNAL COMPONENT MOUNTING PLATE
3	MICROX MOTHERBOARD PCB
4	MICROX CONTROL PCB
5	SAMPLE FLOW RESTRICTOR
6	SAMPLE PRESSURE REGULATOR (SET@ 5PSIG)
7	OXYGEN SENSOR
8	FRONT PLATE
9	MICROX USER INTERFACE PCB
10	INTERCONNECTION RIBBON CABLE

3.1.4 Mounting Locations and Installation

The Microx Online is a fixed gas detection system and should be installed so as to provide effective analysis of a process sample, either at end of line or from a process pipeline or vessel. The Alarm indication thus rendered by the Microx Online should be able to initiate the following actions as required:

Indication of 'Alarm' level oxygen content.
Shut Down of process or plant.
Alarm relayed back to customer PLC/DCS.

In general, fixed systems should be installed so that maintenance of failure of one of the instrument does not compromise the safety of the process being measured.

Factors to take into consideration when choosing a location to mount the Microx Online:

Location of suitable process sample point.
Visibility of status indicator tower (Light Tower)
Sufficient space on vertical surface or wall for secure mounting and access to the instrument.
Nature of gas to be measured.
Pressure of gas to be measured at point of sample take-off.
Routing of sample in and exhaust pipework.

The Microx Online has 6mm Bulkhead Compression fittings for Sample In and Sample Out(Exhaust) pipe work. Typically the Pipework is of Stainless Steel but flexible PVC or other tube could be used if space limitations or other factors favour this.

It is the end user's responsibility to ensure the correct and suitable pipe or tube is used for the installation.

3.4 RS232 connections

Micro	PC Connections		
Function	Function	9-way 'D'	25-way 'D'
TxD	RxD	2	3
RxD	TxD	3	2
0V	0V	5	9

3.5 Analogue Output

The analogue output provides a means of indicating to external equipment (e.g. data loggers, remote displays) the gas levels currently being detected by the system. The output is that of a Current Source (4-20mA), where 4mA represents zero gas and 20mA represents gas at the sensor FSD.

4 SOFTWARE FEATURES

The menu system featured within the Microx Online allows all calibration and configuration activities to be performed.

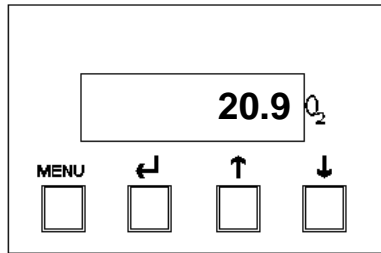

A B C D

The keypad has the following functionality:

Button	Function	Alternate Function
A	Menu Open/Close	
B	Enter	
C	Next (Increment)	
D	Previous (Decrement)	

4.1 Password

The Microx Online uses a password system to restrict the end user from carrying out certain changes that may compromise the use of the equipment.

The menu system is split into two areas, user and engineer. The user has access to menu options E:1 to E:9, while the engineer has access to menu options E:1 to E:19.

See the end of this document (5.2) for password access information.

Menu options

Menu option	Function
E:1	Calibrate Sensor
E:2	Analogue output FSD
E:3	Set 4 mA
E:4	Set 20 mA
E:5	Sensor simulation
E:6	Customer Access Not permitted
E:7	Customer Access Not permitted
E:8	Diagnostics
E:9	Restore
E:10	Customer Access Not permitted
E:11	Customer Access Not permitted
E:12	% Vol Sensor Gain
E:13	Sensor Damping
E:14	New Sensor Data
E:15	Electronic Zero
E:16	Noise Rejection
E:17	Relay
E:18	Alarm Levels
E:19	Alarm Hysteresis

4.1.1 Menu 1 – Calibrate sensor

This should ideally be performed using certified compressed Gas @20.9% Oxygen. This is typically provided from a portable cylinder with a suitable flow and pressure control adaptor. It may be necessary to disconnect the sample in pipe/tube connection to the Microx Online, and connect a suitable tube from the portable cylinder into the sample in bulkhead fitting.

Alternatively, if 20.9% Oxygen can be introduced safely into the process line, this can be another option for calibration.

Where neither of the above are possible, an Ambient air calibration can be made but as no pressure and hence flow will be behind the Oxygen, the characteristics of the calibration with still Air as opposed to pressurised Air will result in some measurement reading offset of small value, when the sample gas is re-connected.

- Press the MENU button to open the menu system.
- Using the NEXT and PREVIOUS buttons select menu option: **E:1**
- Press ENTER.
- Allow time for sensor to respond/stabilise.
- Using the INC and DEC buttons set the reading to that of the calibration gas level.
- Press ENTER to span the sensor, '---' will be displayed to confirm the sensor span has been performed.

Note: Pressing the MENU button rather than the ENTER button exits the span feature without performing the calibration.

Wait until the reading is stable, if not press the ENTER button to span the sensor.

- Press the MENU button to close the menu system.
Note: The sensor span setting will be displayed (as a percentage value) on exit while the MENU key is pressed. Note that this value is a percentage of the initial calibration value set via "New Sensor Data" in menu E:14. See note below.

Note: On each occasion that a new sensor is connected and calibrated the "New Sensor Data" should be set via the procedure in menu 14. The setting should only be carried out after the calibration and not before. This will ensure that subsequent span setting figures displayed on exit of menu 1 will be valid.

4.1.2 Menu 2 – Analogue output FSD

- Press the MENU button to open the menu system.
- Using the NEXT and PREVIOUS buttons select menu option:
E:2
- Press ENTER.
- Using the INCREASE and DECREASE buttons adjust the FSD to the required level.
- Press ENTER.
Note: Pressing the MENU button rather than the ENTER button exits the sensor FSD feature without any change.
- Press the MENU button to close the menu system.
Note: The Sensor FSD will be displayed on exit while the MENU key is pressed.

4.1.3 Menu 3 – Set 4 mA output

- Monitor the current sourced from the analogue output of the OEM module using a multimeter set to read milliamps.
- Press the MENU button to open the menu system.
- Using the NEXT and PREVIOUS buttons select menu option:
E:3
- Press ENTER.
- Using the INCREASE and DECREASE buttons adjust the output to 4mA .
- Press ENTER.
Note: Pressing the MENU button rather than the ENTER button exits the 4 mA feature without performing the calibration.
- Press the MENU button to close the menu system.
Note: The 4 mA factor will be displayed on exit.

4.1.4 Menu 4 – Set 20 mA output

- Monitor the current sourced from the analogue output of the OEM module using a multimeter set to read milliamps.
- Press the MENU button to open the menu system.
- Using the NEXT and PREVIOUS buttons select menu option: **E:4**
- Press ENTER.
- Using the INCREASE and DECREASE buttons adjust the output to 20 mA.
- Press ENTER.
- Press the MENU button to close the menu system.
Note: The 20 mA factor will be displayed on exit.

4.1.5 Menu 5 – Analogue Output Simulation

The Gasnz analogue output can be tested for functionality via menu 5. This option allows the user to simulate the analogue output.

- Press the MENU button to open the menu system.
- Using the NEXT and PREVIOUS buttons select menu option: **E:5.**
- Use the UP and DOWN button to increase or decrease the analogue output. The value displayed on the Microx display will be equivalent to the analogue output.
- Press the MENU button to close the menu system.
Note: The module will return to the conditions on entry.

4.1.6 Menu 6 – Sensor selection

Warning
The Gasenz is supplied configured for the Sensor type with which it is to be used.
Customer adjustment of this setting is not permitted.
Adjusting this setting will render the Gasenz inoperable.

4.1.7 Menu 7

Warning
Customer adjustment of this setting is not permitted. The module will be factory set prior to shipment at “0”. Changing this value may limit the performance and, in extreme cases, the instrument may no longer detect gas.

4.1.8 Menu 8 - Diagnostics

This feature is a view-only feature. No configuration changes are possible from within this menu.

- Press the MENU button to open the menu system.
- Using the NEXT and PREVIOUS buttons select menu option:
E:8
- Press ENTER.
- The display will alternate between the current value and diagnostic code **E:8x**: where x is:
 - 0 Sensor signal, A to D counts low ppm range.
 - 1 Sensor signal, A to D counts high ppm range.
 - 2 Sensor signal, A to D counts %vol range.
 - 3 Firmware version.
- The diagnostic code can be selected by pressing the UP button.
- Press MENU to return the instrument to its standard mode of operation.

4.1.9 Menu 9 - Restore

Customer adjustment of this setting is not permitted.

4.1.10 Menu 10 – Zero offset

Customer adjustment of this setting is not permitted.

4.1.11 Menu 11 – PPM sensor Gain

Customer adjustment of this setting is not permitted.

4.1.12 Menu 12 – % vol sensor gain

This option is used to allow the user to adjust the sensor gain for optimal performance. Care should be taken when using this option, which is normally only used when a new sensor is fitted.

Warning

Customer adjustment of this setting is not recommended. The module will be factory set prior to shipment at a value appropriate to the sensor type fitted. Otherwise changing this value may limit the performance and, in extreme cases, the instrument may no longer detect gas.

The display alternates between the sensor signal level, indicated as a number between 0 and 4095, and the menu number, E:11. The value used should be about 3500.

The display indicates the gain setting when the Up / DOWN keys are pressed. The gain is between 0 and 31, a typical value would be 3.

Apply 13 mV to the sensor input.

- Press MENU to open the menu system.
- Using the NEXT and PREVIOUS buttons, select menu option:
E:12
- Press ENTER. The display shows the sensor peak output level.
- Use the INCREASE and DECREASE buttons to set the required signal level.

Note: When the INCREASE and DECREASE buttons are being operated the display shows the amplifier gain setting as a number between 0 and 31. The larger the number the higher the gain, the lower the signal reading.

- Press ENTER to store the new value.
Note: Pressing the MENU button rather than the ENTER button exits without any change.
- Press MENU to close the menu system.
Note: The signal gain setting will be displayed on exit while the MENU key is pressed.

4.1.13 Menu 13 – Sensor damping

Oxygen sensors output change when subjected to pressure changes. The damping option is used to allow the user to reduce the effects of sudden changes by applying digital filtering. The larger the number the more the signal damping that is applied.

Note: The minimum setting is 5.

- Press MENU to open the menu system.
- Using the NEXT and PREVIOUS buttons, select menu option: **E:13**
- Press ENTER. The display shows the damping factor that is applied to the sensor.
- Use the INCREASE and DECREASE buttons to set the required damping level.
- Press ENTER to store the new value.
Note: Pressing the MENU button rather than the ENTER button exits without any change.
- Press MENU to close the menu system.
Note: The signal damping setting will be displayed on exit while the MENU key is pressed.

4.1.14 Menu 14 – New sensor data

This option allows the initial sensor calibration data to be set. It is used to predict the remaining sensor life.

- Press MENU to open the menu system.
- Using the NEXT and PREVIOUS buttons, select menu option: **E:14**
- Press ENTER. The display displays E:14
- Press ENTER to store the new data in the memory.
Note: Pressing the MENU button rather than the ENTER button exits without any change.
- Press MENU to close the menu system.

4.1.15 Menu 15 – Electronics zero

Disconnect the sensor and place a short at the sensor input to simulate 0% oxygen.

- Press the MENU button to open the menu system.
- Using the NEXT and PREVIOUS buttons select menu option: **E:15**
- Press ENTER.
- Press ENTER to zero the sensor, '---' will be displayed to confirm the sensor zero has been performed.
Note: Pressing the MENU button rather than the ENTER button exits the zero feature without performing the calibration.
- Press the MENU button to close the menu system.

4.1.16 Menu 16 – Noise Rejection

Warning

Customer adjustment of this setting is not recommended. The module will be factory set prior to shipment at a value appropriate to the sensor type fitted. Otherwise changing this value may limit the performance and, in extreme cases, the instrument may no longer detect gas.

The unit has a noise rejection value associated with the reading and displaying of the measured gas level.

The noise rejection value is expressed in number of readings that must be within approximately 20 counts on the AtoD converter of each other before the display is updated. It takes a value of between 0 and 9, where 0 is no rejection and 9 is the maximum jejection.

Setting the noise rejection results in a two second delay for quick changing gas levels.

- Press MENU to open the menu system.
- Using the NEXT and PREVIOUS buttons, select menu option: **E:16**
- Press ENTER. The display shows the Noise rejection value.
- Use the UP / DOWN keys to set the desired level.
- Press ENTER to store the new value in the memory.
Note: Pressing the MENU button rather than the ENTER button exits without any change.
- Press MENU to close the menu system.

Note each range noise rejection differs in the equivalent gas level as follows:

Range %vol	Fixed A to D Counts	Typical span factor	Equivalent gas level %vol
0.00 - 0.0200	20	0.05	0.0001
0.02 - 0.1000	20	0.3	0.0006
0.10 – 1.0000	20	3.5	0.0070
0.0 – 5.0	20	0.004	0.08
5.0 – 25.0	20	0.013	0.26

4.1.17 Menu 17 – Relay

The unit is fitted with three relays that are operated in conjunction with one of three alarm levels.

Relay 1 is associated with alarm level 1.

Relay 2 is associated with alarm level 2.

Relay 3 is associated with alarm level 3.

The user can select if the relay is normally Energized, 'E' or normally de-energised, 'd' when the unit is **not** in an alarm condition. The relay can also be set to act on rising, 'r' or falling 'F' gas levels.

This option allows the user to configure the operation of the relays.

- Press MENU to open the menu system.
- Using the NEXT and PREVIOUS buttons, select menu option:
E:17
- Press ENTER. The display displays r:1
- Use the UP / DOWN keys to select the desired relay.
- The display will show the following:
E:r Normally energized, rising alarm
d:r Normally de-energized, rising alarm
E:F Normally energized, falling alarm
d:F Normally de-energized, falling alarm
- The mode of operation can be changed by pressing the UP button.
- Press ENTER to store the new data in the memory.
Note: Pressing the MENU button rather than the ENTER button exits without any change.
- Press MENU to close the menu system.

4.1.18 Menu 18 – Alarm levels

Note: When the option of the Light Tower indicator is fitted, Relays 1 or Relays 1 and 2 will be used to operate the Red, Green Lamps and Audible alarm. Thus only Relay 3 is typically available for customer interface connection. The programming of Relay 3 can be matched to either Relay 1 or Relay 2 or another Oxygen level setting as required..

This option allows the user to set the operation of the alarm levels. There are three alarms levels associated with 3 relays.

Alarm level 1 is associated with relay 1.

Alarm level 2 is associated with relay 2.

Alarm level 3 is associated with relay 3.

- Press MENU to open the menu system.
- Using the NEXT and PREVIOUS buttons, select menu option:
E:18
- Press ENTER. The display displays A:1
- Use the UP / DOWN keys to select the desired alarm level.
- Press ENTER. The display shows the alarm level.
- Use the UP / DOWN keys to set the desired alarm level.
- Press ENTER to store the new value in the memory.
Note: Pressing the MENU button rather than the ENTER button exits without any change.
- Press MENU to close the menu system.

4.1.19 Menu 19 – Alarm hysteresis

The unit has a hysteresis value associated with the alarm levels to avoid relay chattering as the unit goes in and out of alarm conditions.

The hysteresis value is expressed as a percentage of the alarm set point and takes a value of between 0 and 10.

- Press MENU to open the menu system.
- Using the NEXT and PREVIOUS buttons, select menu option:
E:19
- Press ENTER. The display shows the hysteresis level.
- Use the UP / DOWN keys to set the desired level.
- Press ENTER to store the new value in the memory.
Note: Pressing the MENU button rather than the ENTER button exits without any change.
- Press MENU to close the menu system.

5 ROUTINE MAINTENANCE & SERVICING

The Microx Online will provide reliable and fault free service when given regular maintenance and calibrations.

5.1 Routine Inspection and Maintenance

It is advisable to periodically inspect the installation:

Clean gas detector head using a clean DAMP cloth.

Inspect the sensor and ensure it is sound and the sensor-housing aperture is not obstructed (where applicable).

The maximum time interval between routine inspections should be assessed by the calibrating personnel and will depend upon the environment in which the equipment is installed.

5.2 Sensor Replacement

This procedure requires powering off the Instrument.

Open the instrument door.

Disconnect the oxygen Sensor connection cable from the terminals on the internal board .

Next, unscrew the hexagon compression fitting nut which secures the Oxygen Sensor.

Withdraw the Sensor. Replacement is a reversal of the above procedure.

Perform a calibration as described in the relevant sections of this manual.

5.3 Password.

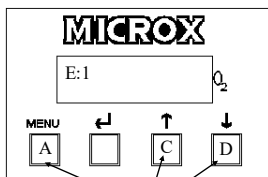

Press the **Next** (increment) button (C)
 And the **Previous** (decrement) button (D)
 Together and at the same time, press the
Menu button (A).
E:1 is now displayed.

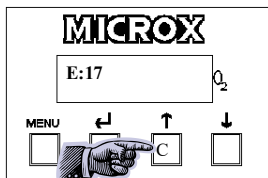

Use the **Next** (Increment) button (C) until
 The desired menu level is displayed.
 Follow the instructions in the Microx user
 manual for specific menu entry.

